

TASS



Copyright ©2019 Bygghemma Sverige AB. Original content rights reserved. All product names, logos, and brands are property of their respective owners.



Information contained within this document was considered accurate at the time of publication, but may be subject to revision.



bathlife®

OF SWEDEN



EN **TABLE OF CONTENTS**

SV **INNEHÅLLSFÖRTECKNING**

NO **INNHOLDSFORTEGNELSE**

DK **INDHOLDFORTEGNELSE**

FI **SISÄLLYSLUETTELO**

 Maintenance/skötsel/vedlikehold/vedligeholdelse/hoito	3
 Connection/anslutning/forbindelse/yhteys	5
 Tools/verktyg/verktøy/værktøjer/työkalut	6
 Components/komponenter/komponentit	7
 Assembly/montering/montage/kokoonpano	9
 Operation/handhavande/bruk/brug/toiminta	14



Copyright ©2019 Bygghemma Sverige AB. Original content rights reserved. All product names, logos, and brands are property of their respective owners.



Information contained within this document was considered accurate at the time of publication, but may be subject to revision.



- EN **If you have questions**, please contact us.
 SV **Om du har frågor**, vänligen kontakta oss.
 NO **Hvis du har spørsmål**, om produktet eller manualen.
 DK **Hvis du har spørgsmål**, til dette produkt eller manual.
 FI **Jos sinulla on kysyttävää**, ota yhteyttä.



- EN **If any part is broken**, do not use the product before repairing it.
 SV **Om någon del är defekt**, åtgärda detta innan produkten brukas.
 NO **Hvis noen del er ødelagt**, ikke bruke produktet før reparasjoner.
 DK **Hvis nogen del er brudt**, ikke bruge produktet før du reparerer det.
 FI **Jos jokin osa on rikki**, älä käyttää tuotetta ennen sen korjaamista.

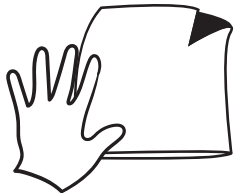

- EN **When cleaning in general**, use a soft cloth and protective gloves.
 SV **Vid allmän rengöring**, använd en mjuk trasa och skyddande handskar.
 NO **Ved generell rengjøring**, bruk en myk klut og vernehansker.
 DK **Ved general rengøring**, brug en blød klud og beskyttelseshandsker
 FI **Kun puhdistat yleensä**, käytä pehmeää kangasta ja suojakäsineitä.



- EN **When cleaning stains**, do not use bleaching or abrasive chemicals.
 SV **Vid rengöring av fläckar**, använd inte blekande eller slipande kemikalier.
 NO **Ved rengjøring av flekker**, ikke bruk blekemidler eller slitende kjemikalier.
 DK **Ved rengøring af pletter**, brug ikke blegemidler eller slibende kemikalier.
 FI **Kun puhdistat tahroja**, älä käyttää valkaisu- tai hankaavia kemikaaleja.



Copyright ©2019 Bygghemma Sverige AB. Original content rights reserved. All product names, logos, and brands are property of their respective owners.



Information contained within this document was considered accurate at the time of publication, but may be subject to revision.



EN Risky tired/under influence
SV Riskabelt om trött/påverkad
NO Risikoen er trøtt/drabbad
DK Risikoen er træt/berørt
FI Riskialtista väsynyt/päihtynyt



EN Supervise children age 0-5
SV Håll barn 0-5 under uppsikt
NO Hold barn 0-5 under tilsyn
DK Hold børn 0-5 under opsyn
FI Pidä lapset 0-5 valvonna alla



EN Do not overheat the water
SV Överhetta ej vattnet
NO Ikke overopphetende vann
DK Overophed ikke vand
FI Älä ylikuumentaa vettä



EN Wet surfaces slippery
SV Våta ytor halkiga
NO våte overflater glatte
DK våde overflader glatte
FI Märkä pinta liukas



EN Notice height differences
SV Tänk på höjdskillnader
NO Tenk på høydeforskjeller
DK Tænk på højdeforskelle
FI Ajattele korkeuseroja



EN Notice pinching risks
SV Tänk på klämrisker
NO Tenk på klemt risiko
DK Tænk på at klemme risici
FI Ajattele riskien puristamista



EN Smoking can discolour acrylic
SV Rökning kan missfärga akryl
NO Røyking kan misfarge akryl
DK Rygning kan misfarve akryl
FI Tupakointi voi värjätä akryylia



EN Keep carton indoors
SV Förvara lådan inomhus
NO Hold boksen innendørs
DK Hold kassen indendørs
FI Pidä laatikko sisätiloissa



Copyright ©2019 Bygghemma Sverige AB. Original content rights reserved. All product names, logos, and brands are property of their respective owners.



Information contained within this document was considered accurate at the time of publication, but may be subject to revision.



- EN **Hire licensed professionals** when appropriate.
 SV **Anlita licensierade hantverkare** när så krävs.
 NO **Leie lisensierte lisensierte fagfolk** når det er nødvendig.
 DK **Leje licenserede autoriserede fagfolk** når det kræves.
 FI **Vuokraa llisensoidut ammattilaiset** tarvittaessa.



- EN **Do not use/maintain with dirty water.** Filter when necessary.
 SV **Använd/underhåll inte med smutsigt vatten.** Filtrera vid behov.
 NO **Ikke bruk/vedlikehold med skittent vann.** Filter når nødvendig.
 DK **Ikke brug/vedligehold med snavset vand.** Filtrer når nødvendigt.
 FI **Älä käytä/säilytä likaa vettä.** Suodata tarvittaessa.



MAX



39 °C



60 °C

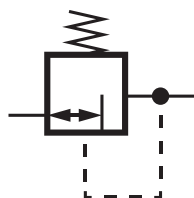

MAX 800 kPa (8.0 bar)

MIN 230 kPa (2.3 bar)



Copyright ©2019 Bygghemma Sverige AB. Original content rights reserved. All product names, logos, and brands are property of their respective owners.



Information contained within this document was considered accurate at the time of publication, but may be subject to revision.

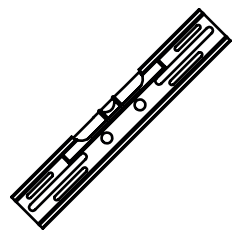

EN Spirit-level
 SV Vattenpass
 NO Vaterpass
 DK Vaterpas
 FI Vatupassi

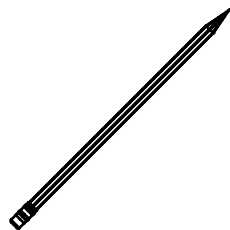

Pen/penn/penna/
 kynä



17 mm

EN Spanner
 SV Skruvnyckel
 NO Skiftenøkkel
 DK Skruenøgle
 FI Ruuviavain

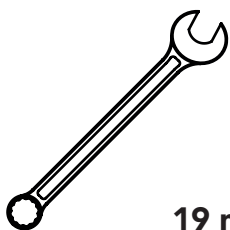

19 mm

EN Spanner
 SV Skruvnyckel
 NO Skiftenøkkel
 DK Skruenøgle
 FI Ruuviavain

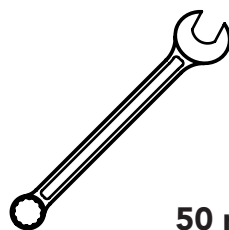

50 mm

EN Spanner
 SV Skruvnyckel
 NO Skiftenøkkel
 DK Skruenøgle
 FI Ruuviavain



Copyright ©2019 Bygghemma Sverige AB. Original content rights reserved. All product names, logos, and brands are property of their respective owners.



Information contained within this document was considered accurate at the time of publication, but may be subject to revision.



A1

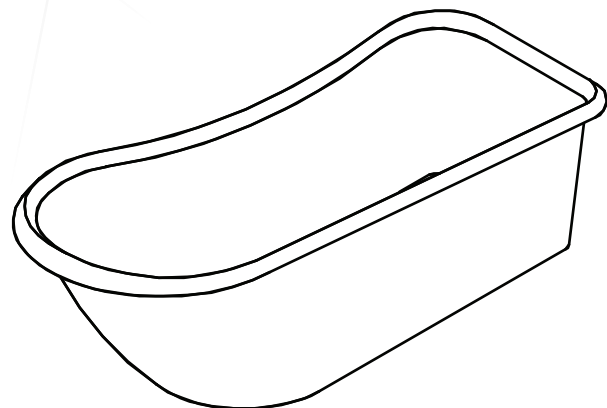

A2 x4



B1 x4

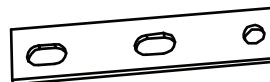

B2 x8

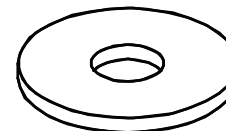

B3 x8 (M17)

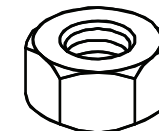

B4 x4

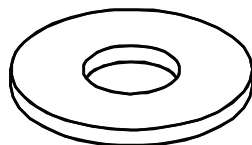

B5 x4



B6 x4 (M19)

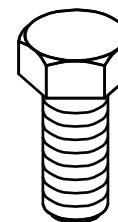

B7 x4

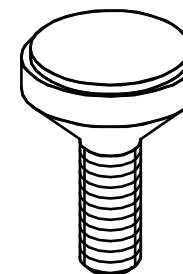

Copyright ©2019 Bygghemma Sverige AB. Original content rights reserved. All product names, logos, and brands are property of their respective owners.



Information contained within this document was considered accurate at the time of publication, but may be subject to revision.

C1

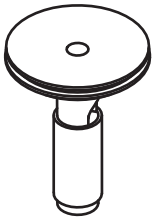

C2

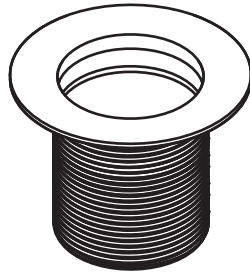

C3

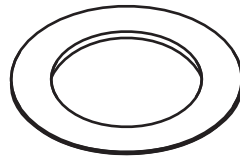

C4 (M50)

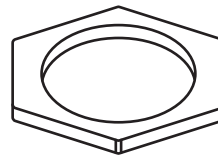

C5

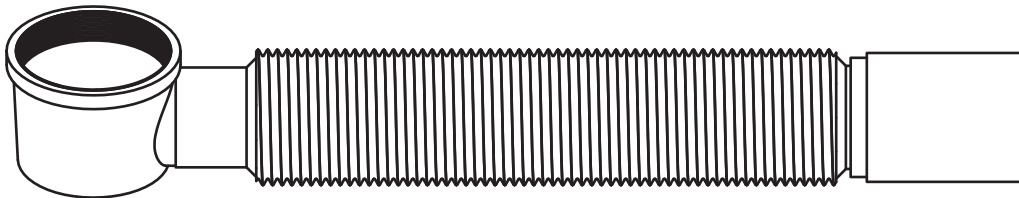

Copyright ©2019 Bygghemma Sverige AB. Original content rights reserved. All product names, logos, and brands are property of their respective owners.



Information contained within this document was considered accurate at the time of publication, but may be subject to revision.



1

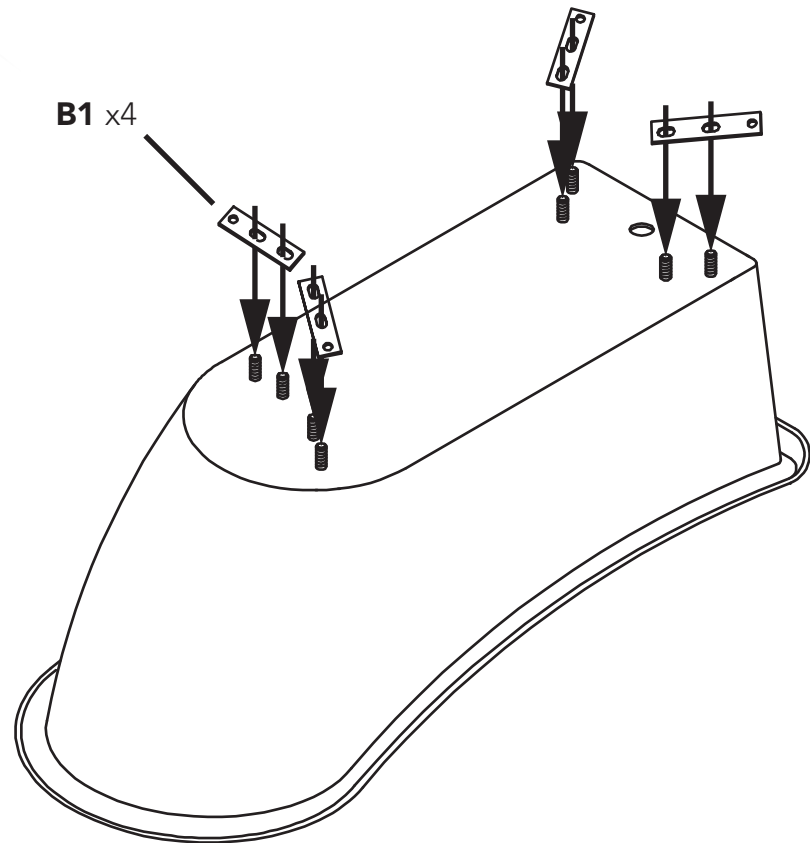

2

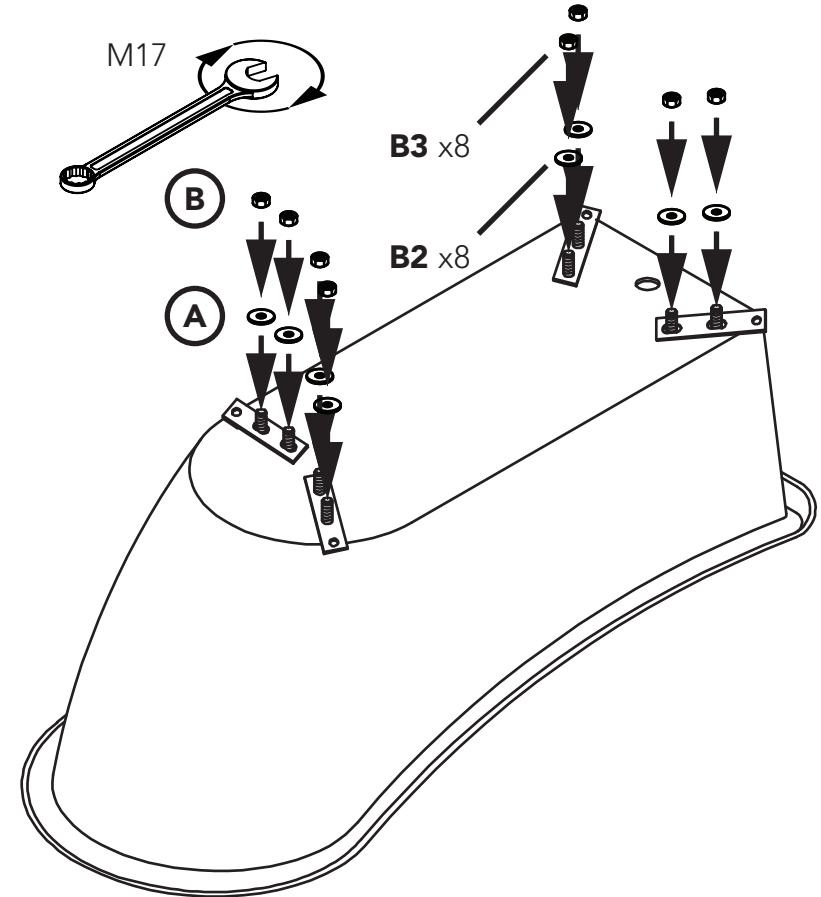

Copyright ©2019 Bygghemma Sverige AB. Original content rights reserved. All product names, logos, and brands are property of their respective owners.



Information contained within this document was considered accurate at the time of publication, but may be subject to revision.

3

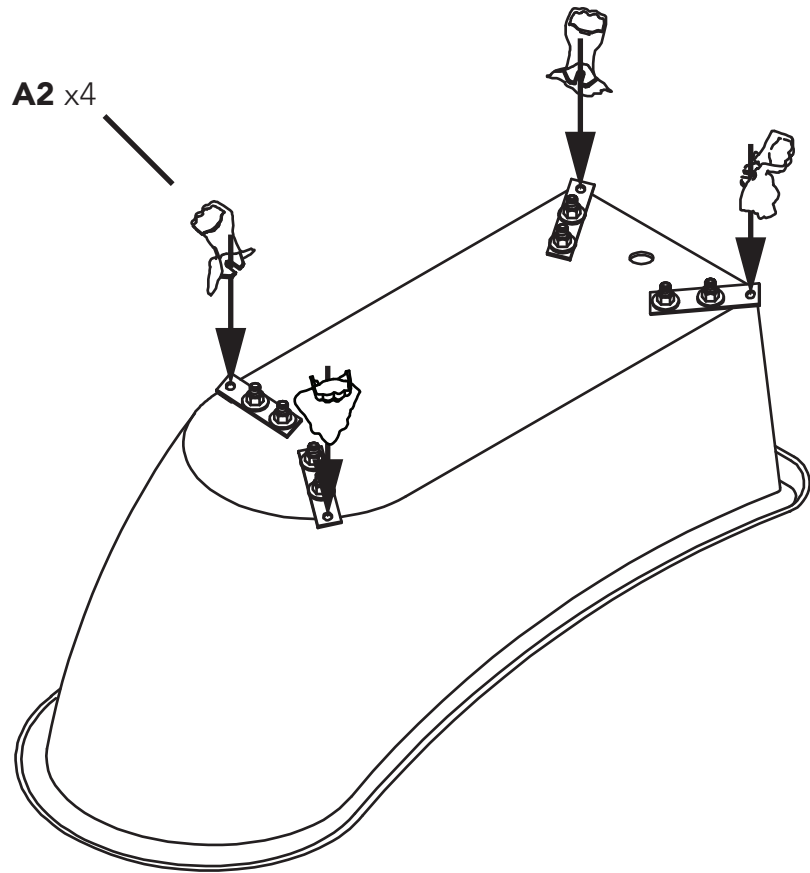

4

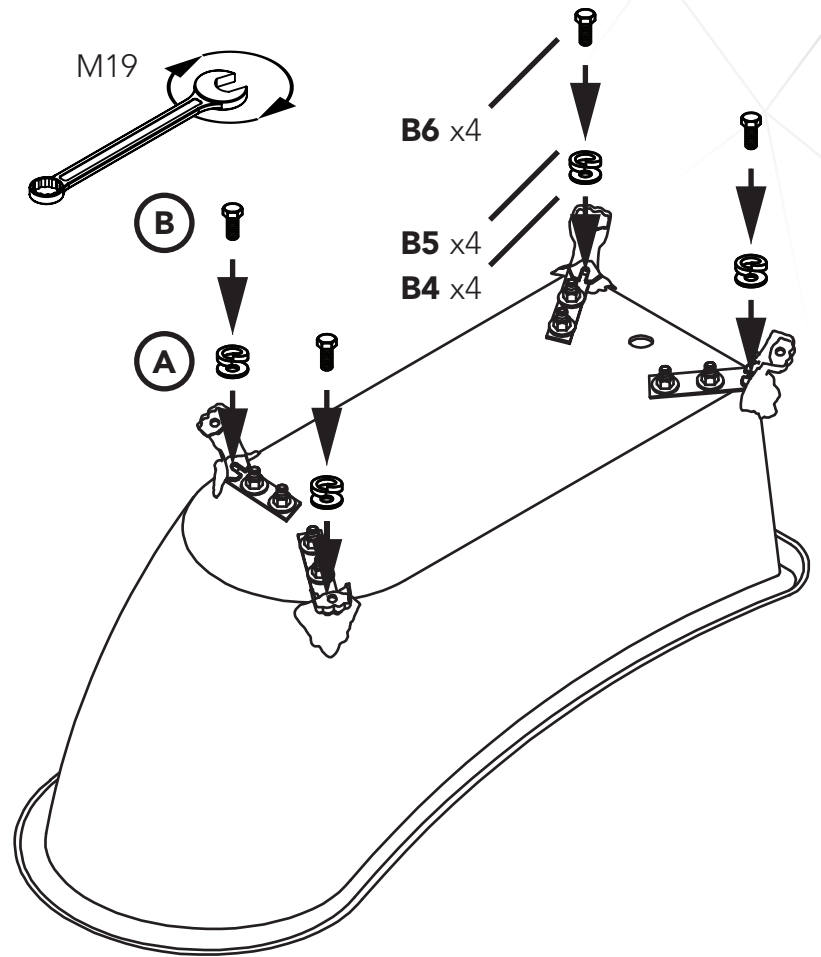

Copyright ©2019 Bygghemma Sverige AB. Original content rights reserved. All product names, logos, and brands are property of their respective owners.



Information contained within this document was considered accurate at the time of publication, but may be subject to revision.

5

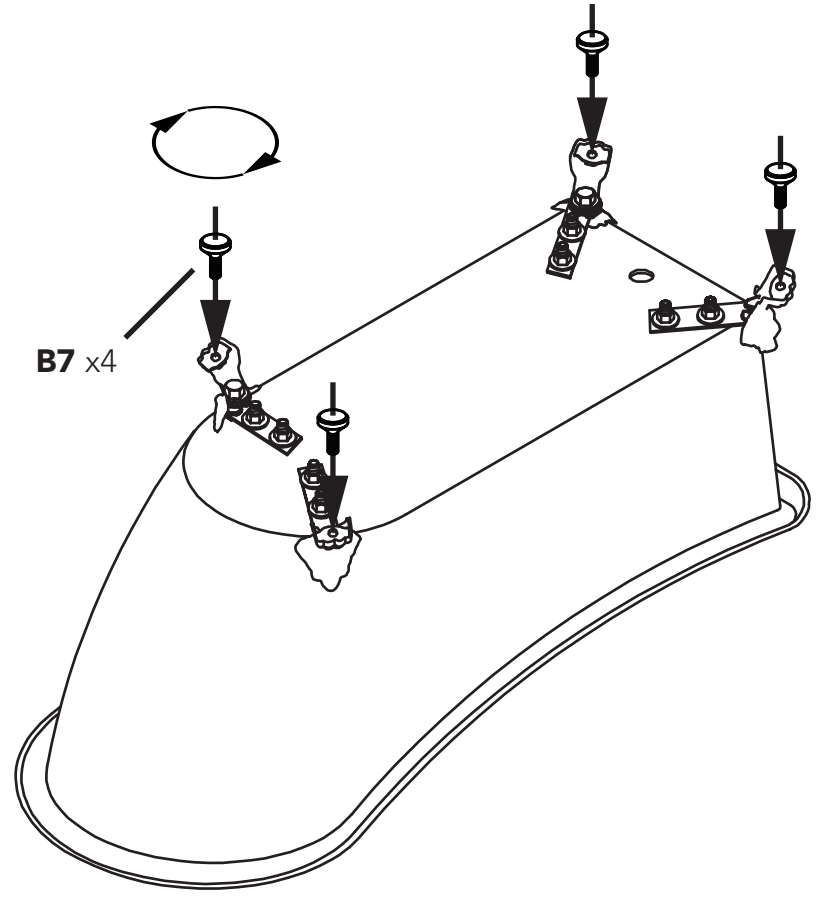

6

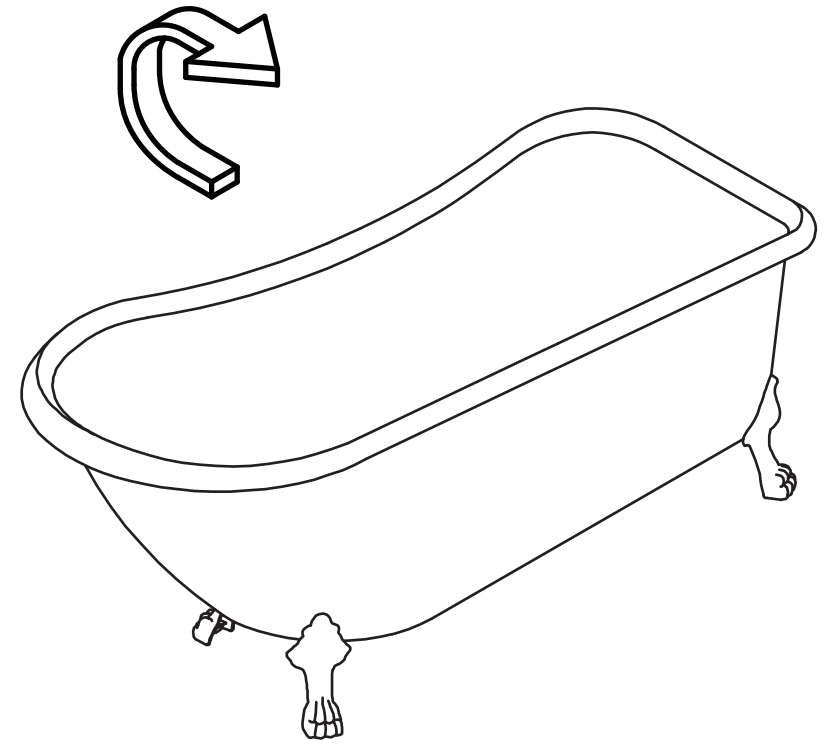

Copyright ©2019 Bygghemma Sverige AB. Original content rights reserved. All product names, logos, and brands are property of their respective owners.



Information contained within this document was considered accurate at the time of publication, but may be subject to revision.

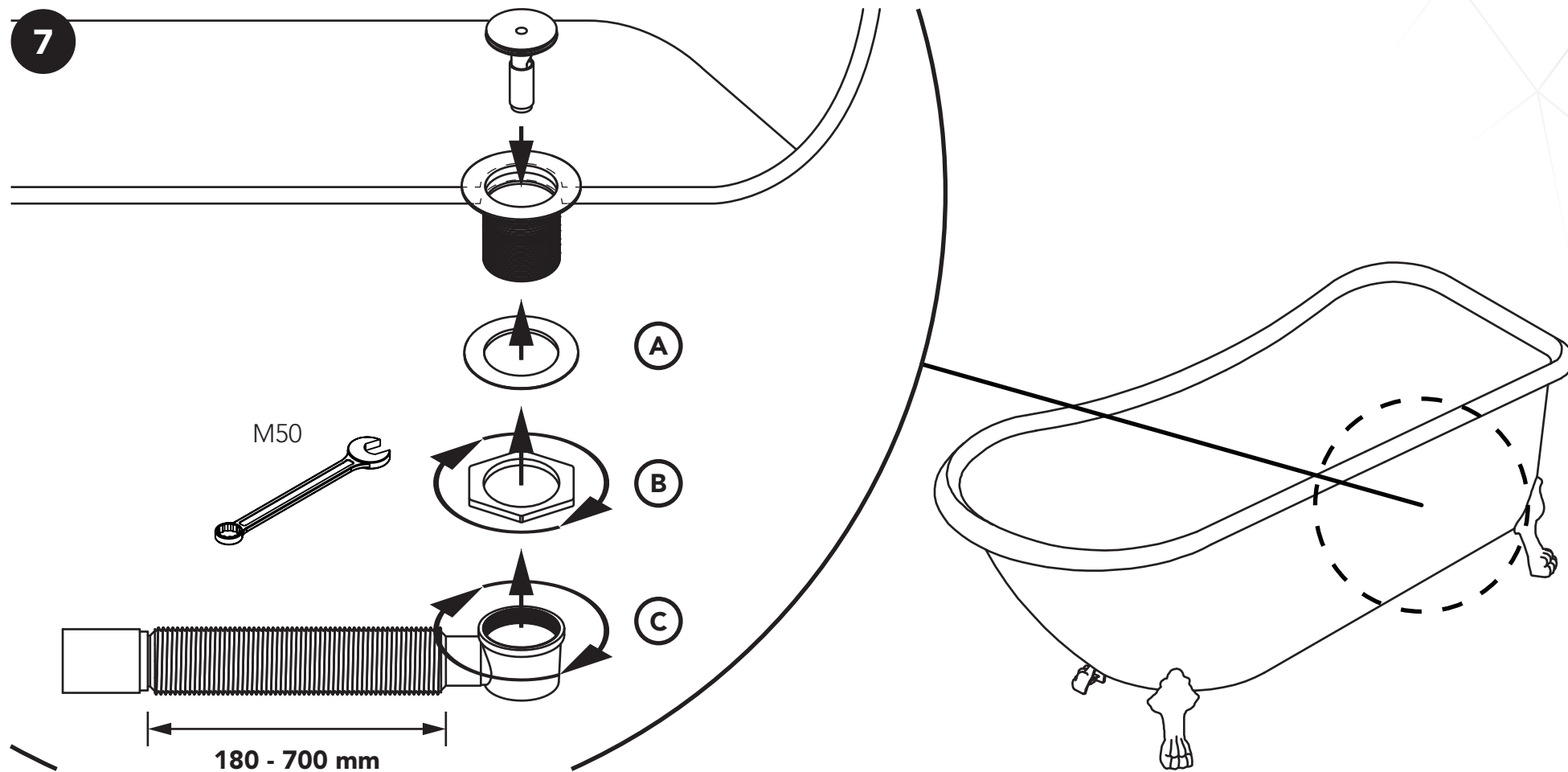

Copyright ©2019 Bygghemma Sverige AB. Original content rights reserved. All product names, logos, and brands are property of their respective owners.



Information contained within this document was considered accurate at the time of publication, but may be subject to revision.

8

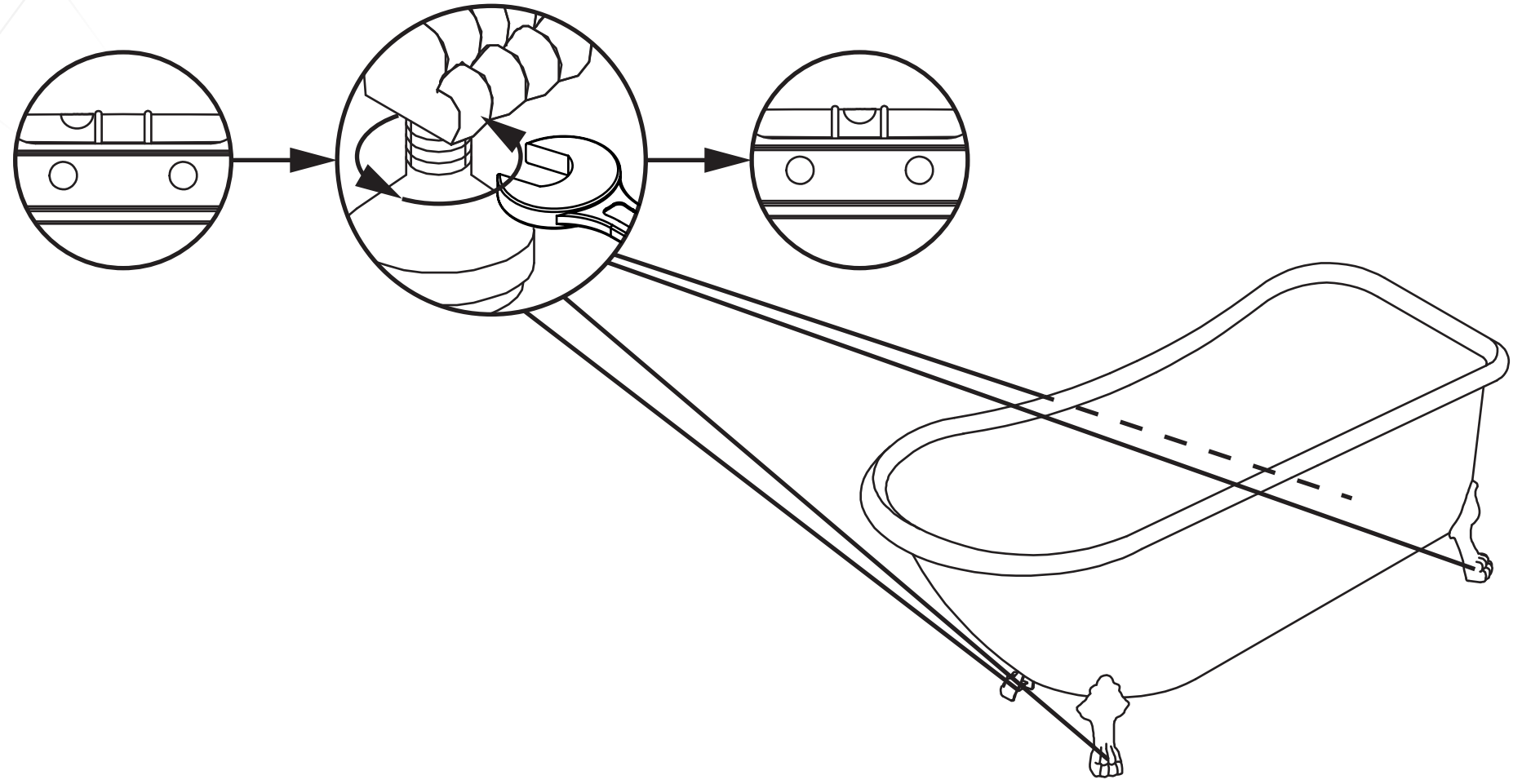

Copyright ©2019 Bygghemma Sverige AB. Original content rights reserved. All product names, logos, and brands are property of their respective owners.



Information contained within this document was considered accurate at the time of publication, but may be subject to revision.



POP-UP DRAIN/BOTTENVENTIL/BUNNVENTIL/ BUNDVENTIL/POHJAVENTTIILI

- EN Push the pop-up drain to alternate between the open and closed modes.
- SV Tryck ned bottenventilen för att växla mellan öppet och stängt läge.
- NO Trykk ned på bunnventilen for å veksle mellom åpen og lukket stilling.
- DK Tryk ned på bundventilen for at skifte mellem de åbne og lukkede tilstande.
- FI Paina pohjaventtiiliä alaspäin vaihtaaksesi avoimen ja suljetun tilan välillä.

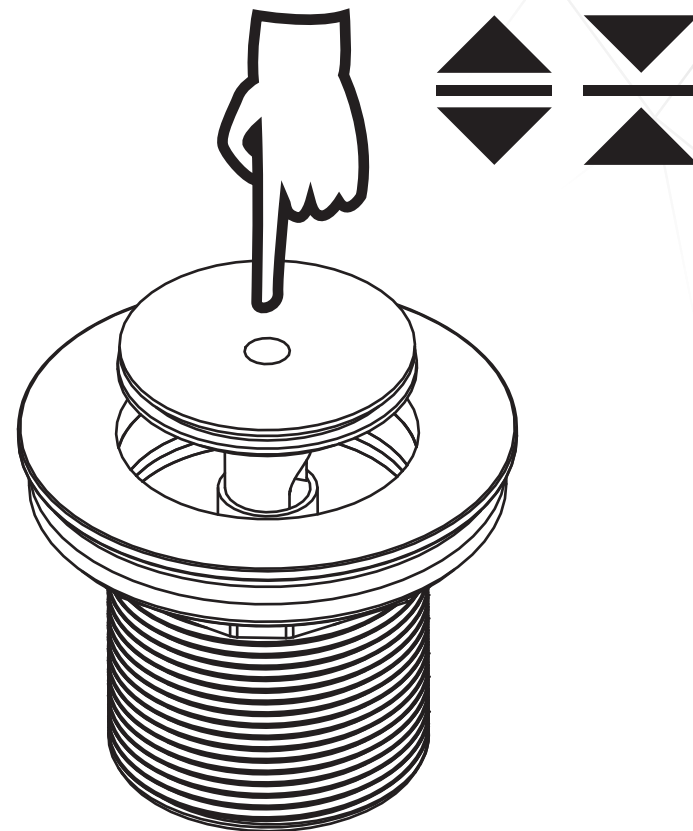

Copyright ©2019 Bygghemma Sverige AB. Original content rights reserved. All product names, logos, and brands are property of their respective owners.



Information contained within this document was considered accurate at the time of publication, but may be subject to revision.





Copyright ©2019 Bygghemma Sverige AB. Original content rights reserved. All product names, logos, and brands are property of their respective owners.



Information contained within this document was considered accurate at the time of publication, but may be subject to revision.

DESIGN BATHLIFE OF SWEDEN
MADE IN PRC
bathlifeofsweden.com

BYGGHEMMA SVERIGE AB
POSTMÄSTAREGATAN 18
572 30 OSKARSHAMN, SWEDEN

OMS-802A(B)
CHROME PLATE METAL FEET
GOLD METAL FEET
BLACK METAL FEET
WHITE METAL FEET



DOP TAS153U1HGWPAC-01
DOP TAS153U1GGWPGAC-01
DOP TAS153U1GGWPBAC-01
DOP TAS153U1GGWPWAC-01

EN 14516:2006+A1:2010 (2014) ✓
Cleanability ✓
Durability ✓

